

Smoå mirror (Wall-mounted Version)

Installation and Operating Instructions

■ Smoå mirror (Wall-mounted Version)
AY-M2AC

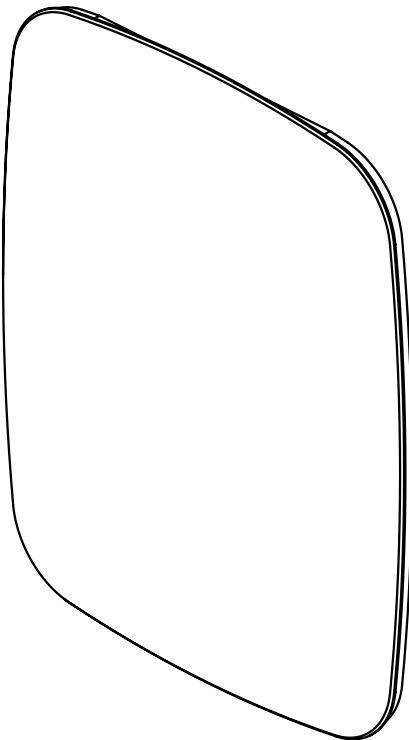

Table of Contents

| | |
|--------------------------------|---|
| Description of Warning Symbols | 2 |
| Safety Precautions | 2 |
| Precautions for Use | 3 |
| Before Using the Product | 3 |
| Accessories | 4 |
| Before Installation | 4 |
| Installing the Product | 4 |
| Maintenance Method | 5 |
| Daily Inspection | 6 |
| Standard Period of Use | 6 |
| Consumables | 6 |
| Disposal of the Product | 6 |
| Specifications | 6 |
| Product Dimension Diagram | 7 |

To installers

- Please read the installation and handling instructions carefully before installation and install the product correctly.
- After installation is complete, please give these instructions to the customer.

To customers

- Please ask a professional contractor or Takara Belmont to install the product. Never attempt to install the product yourself.

※The actual product appearance and the images and dimensions given here are subject to change without notice for the purposes of improvement.

Thank you for purchasing this Takara Belmont product.

Please read the Installation and Operating Instructions carefully before use and use the product correctly. Failing to read the Installation and Operating Instructions before use may lead to accidents.

Keep this booklet safe near the product so that it can be referred to promptly, and be sure to read this booklet again when necessary. This product is an industrial appliance designed for use by hairdressing salons. The product must only be used by professionals such as hair stylists. Only use this product for its intended purpose. If you have any questions about the Installation and Operating Instructions or the product, please contact us. If the Installation and Operating Instructions become illegible due to stains and tears, or if this booklet is misplaced, please request a copy from Takara Belmont using the inquiry number shown in the box below.

Version1 2024.7

1E0AK6A0 (Inquiry No.)

Description of Warning Symbols

■ Before using the product ...







Please be sure to read the Safety Precautions and Precautions for Use carefully and use the product correctly.

■ Precautions shown on this page

These are intended for the safe use of the product and to prevent harm and damage to users and other people. All of the precautions shown are important details related to safety. Please be sure to follow these precautions. If an accident occurs due to a failure to follow the Safety Precautions and Precautions for Use, Takara Belmont is not responsible for any damage or risk to the person using this product or those around them due to accidents. In this case, the person failing to adhere to the Safety Precautions and Precautions for Use will be responsible for any damage or risk incurred.

Detailed descriptions of symbols are provided below. Read and understand these symbols thoroughly before reading this manual.





■ Descriptions of symbols

| | |
|---|--|
|  WARNING | The items explained under this symbol are precautions that may result in deaths or serious injury from the incorrect handling of the product if the warning is not followed. |
|  CAUTION | The items explained under this symbol are precautions that may result in mild or moderate injury or property damage from the incorrect handling of the product if the caution is not followed. |
|  Display of danger, warnings, and precautions in general |  Display for general mandatory action by the user |
|  Display for general prohibitions |  Display for prohibition of disassembly, repair, and modification |

Safety Precautions (items that must be followed)





|  WARNING | |
|--|---|
|  Ensure that the wall has sufficient strength. Flat head self-tapping screws are used to secure the mirror mounting bracket of this product to the wall. Provide a concrete panel with a thickness of 12 mm or more or a backing piece with equivalent strength on the mounting surface. |  Perform cleaning on a stable platform. Use a stable platform when cleaning the top part of the product. Otherwise, you may trip over and become injured. |
|  Do not apply force to the product. Do not apply force to the product. The product may be damaged or fall, resulting in an accident or personal injury. |  Do not lean on or hang from the product. Do not lean on or hang from the product. The product may be damaged or fall, resulting in an accident or personal injury. |
|  Do not disassemble, repair, or modify the product. Unless you are a repair technician, do not attempt to disassemble, repair, or modify the product. |  Do not use for any purpose other than hair/beauty or esthetic services. This product is business-use equipment for hair/beauty salons and esthetic salons etc. Do not use for any purpose other than hair/beauty or aesthetic services. |
|  This product must only be used by barbers, hairdressers, and estheticians. This product is business-use equipment for hair/beauty salons and esthetic salons etc. This product must only be used by properly trained professionals, such as qualified barbers, hairdressers, and estheticians. |  Do not apply force to the product from the side or below. Applying force to the product from the side or below may cause the mirror to move from the mounted position and fall, resulting in an accident or personal injury. |

CAUTION

| | |
|---|--|
| <p> Take care when carrying. When installing the product, support the top part and side part with your hand. Do not hold only the bottom part of the product. Otherwise, the product may become unbalanced, causing it to fall.</p> | <p> Do not use this product outdoors. This product is for indoor use only. Do not install it outdoors or in a vehicle. Be sure to use the product in a hair/beauty salon or esthetic salon. Otherwise, the product may be damaged.</p> |
| <p> Do not apply an impact to the product. Do not apply an impact to the product. The product may be damaged, resulting in personal injury.</p> | <p> Be careful of the corners and uneven parts of the product. When cleaning the product, be careful of the corners and uneven parts of the product. Personal injury may result.</p> |
| <p> Do not expose the product to water. Take care not to expose the product to water. If water gets on the product, wipe it off immediately.</p> | |

Precautions for Use

CAUTION

| | |
|--|---|
| <p> After use, make sure to wipe off any water droplets adhering to the surface. Water droplets that are left unattended may result in permanent stains.</p> | <p> Do not carelessly insert your fingers etc. into the space between the wall and the reverse side of the product. There are screws etc. for securing the product on the reverse side. Carelessly touching them with your fingers etc. may cause personal injury.</p> |
| <p> If chemicals come in contact with the product, wipe them off immediately. If the equipment is stained with chemicals, such as a hair colouring agent, immediately wipe it off. Otherwise, the affected surface may deteriorate, discolour, or deform. Also, if the floor is stained with chemicals, mop them up immediately.</p> | <p> Do not clean the product with chemicals or apply heat to it. Discolouration and deterioration may result. If chemicals get onto the product, wipe them off immediately.</p> |
| <p> Avoid direct sunlight or heat from stoves. Avoid direct sunlight or heat from stoves. Otherwise, discolouration and deterioration may result.</p> | <p> Do not use strong acid or alkaline cleaning chemicals. For cleaning, do not use cleaning chemicals made mainly from sodium hydroxide and potassium hydroxide.</p> |
| <p> Do not hit this product with any object. Do not hit this product with any hard object. If you are carrying a pair of scissors etc, take care not to hit them against the product. Otherwise, the product may be deformed or damaged.</p> | <p> Do not use abrasives. Do not use abrasives for cleaning. Use of abrasives, abrasive sponges, or hard cleaning tools such as metal or nylon scrubbers may leave scratches.</p> |

Before Using the Product

● About the mirror

The mirror is made from float glass that conforms to JIS (Japanese Industrial Standards, R3220:2011) for manufacturing mirrors. Due to the manufacturing process, the glass surface may have some unevenness within the standard. Note that the mirror image is subject to warping within the standard for the product.

Accessories

Check that you have received all the accessories/items included in the package.

Mirror mounting bracket × 1

Cardboard gauge × 1

Installation and operating instructions (this document) × 1

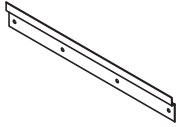

Flat head self-tapping screw $\phi 3.5 \times L25$ × 4

Before Installation

- Before installation, refer to the Product Dimensional Drawing on p.8 to determine the installation position.
- The wall backing for installation on the wall requires the strength of a concrete panel with a thickness of 12 mm or more. In the case of a plasterboard or plywood with a thickness of 12 mm or less, provide a wooden batten at the position where the mirror mounting bracket is to be installed for reinforcement.
- For the wall finish, use a highly waterproof material, such as melamine. (This is because water may splash while shampooing.)

Installing the Product

- < 1 > Temporarily secure the cardboard gauge (whose size is the same as the product), which is included in the package, on the wall to which the product will be installed by applying tape etc.

*The height of the gauge can be set freely.

CAUTION

The cardboard gauge may shrink due to moisture etc. Before installation, make sure to check the width and height of the cardboard gauge and the dimensions of the slit for the mirror mounting bracket in the Product Dimensional Drawing on p.7.

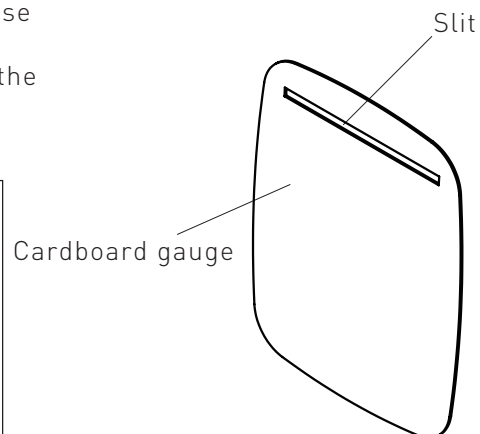

- < 2 > Align the mirror mounting bracket with the slit of the cardboard gauge and secure it to the wall using the designated number of flat head self-tapping screws ($\phi 3.5 \times L25$) included in the package. (Refer to p.4.) Check that the top part of the mirror mounting bracket is level to the ground.

CAUTION

Make sure to check the width and height of the mirror mounting bracket in the Product Dimensional Drawing on p.7. Fine adjustments cannot be made after installation. Make sure to secure the mirror mounting bracket to the wall using the designated number of flat head self-tapping screws included in the package. The product may fall if the number of screws used for securing the product is fewer than the designated number.

Mirror mounting bracket

Flat head self-tapping screw (four)

Cardboard gauge

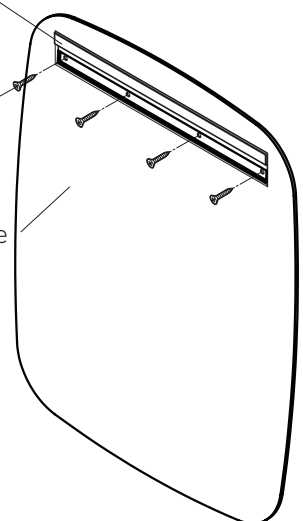

After securing the mirror mounting bracket, remove the cardboard gauge.

< 3 > Gently hook the product onto the mirror mounting bracket. Make fine adjustments of the product in a horizontal direction, and check that the product is securely hooked onto the bracket.

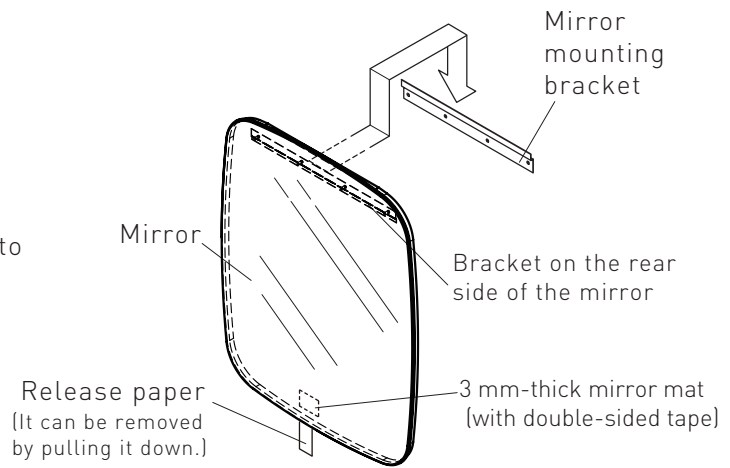

■ After installation is complete, check the following items.

Backlash

Gently push the product to check for significant looseness or backlash.

⇒ If there is significant looseness or backlash, check that the flat head self-tapping screws, which are used to install the mirror mounting bracket, are securely tightened.

Levelness of the product

Abnormalities, including scratches on the exterior

Maintenance Method

- Clean the product every day after the end of the day's work. Stains left uncleaned may become unremovable or lead to the growth of mould.

| | | |
|--------------------|---|--|
| CAUTION | <ul style="list-style-type: none"> ● Never use volatile chemicals such as thinner, alcohol, gasoline, or kerosene; abrasive wax or sponges; detergents containing organic solvents; acid, alkaline, or chlorine-based detergents; or cleaning tools such as scrubbing brushes etc. Scratches, discolouration, etc. may result. | |
|--------------------|---|--|

<Cleaning Precautions>

- Wipe with a dry, soft cloth without applying anything.
- When the product is exposed to water or chemicals, wipe it dry immediately, even before the end of the day's work. Water and chemicals that are left unattended may cause deterioration and corrosion.
- If the product is severely fouled, clean it with neutral detergent diluted in about a 1:10 ratio with water. After wiping with detergent, wipe it with a soft, partially wrung-out cloth, and then wipe it thoroughly with a dry cloth.

| | |
|--------------------|---|
| WARNING | <ul style="list-style-type: none"> ● If it is necessary to use a platform or the like for cleaning, ensure that it is stable. Otherwise, you may trip over and become injured. ● When wiping, hold the side of the product. Otherwise, the product may fall and be damaged etc., resulting in an accident or personal injury. |
|--------------------|---|

| | |
|--------------------|---|
| CAUTION | <ul style="list-style-type: none"> ● Never use metal scrubbers, sandpaper, chemicals containing abrasives, etc. because they cause scratches. ● If the surface is wet with water, wipe it immediately. If left unattended, discolouration and deterioration may result. ● There are screws etc. for securing the product on the reverse side etc. Touching them during cleaning may cause personal injury. Take sufficient care not to touch them. |
|--------------------|---|

Daily Inspection

- To ensure the use of this product for a long period, check the following points at least once a month.

Inspection Check for looseness and inclination of the product, backlash of the mirror, and separation due to failure of adhesion.
◎Such defects may cause the product and the mirror to fall.
<If an abnormality is found>
Stop using the product and contact your local authorised Takara Belmont dealer.

Standard Period of Use

- The standard period of use for this product is seven years.
- Standard period of use is defined as "a guideline for the standard period of using the product without any problems in safety under standard conditions of product use with appropriate maintenance and inspection (including replacement of parts) performed." Please be advised that this is not an indication of the guarantee period, and the standard period will differ depending on the environment (including water quality) and method in which you use the product. Please contact your local authorised Takara Belmont dealer for maintenance after completion of the standard period of use.

Consumables

There are no consumables.

In the case of significant wear and deterioration or damage, inspection or replacement of parts is necessary. Contact your local authorised Takara Belmont dealer.

Scratches, staining, deterioration, fading, etc. of the exterior of this product after use are outside the scope of warranty.

Disposal of the Product

When disposing of the product or replaced parts, waste should be processed appropriately according to current laws and regulations in your country.

Specifications

| Product name | Model | Weight |
|------------------------------------|---------|--------|
| Smoå mirror (Wall-mounted Version) | AY-M2AC | 8 kg |

Usage environment

Ambient temperature : 10 to 40°C

Humidity : 95% or less

Product Dimension Diagram

Smoå mirror (Wall-mounted Version)

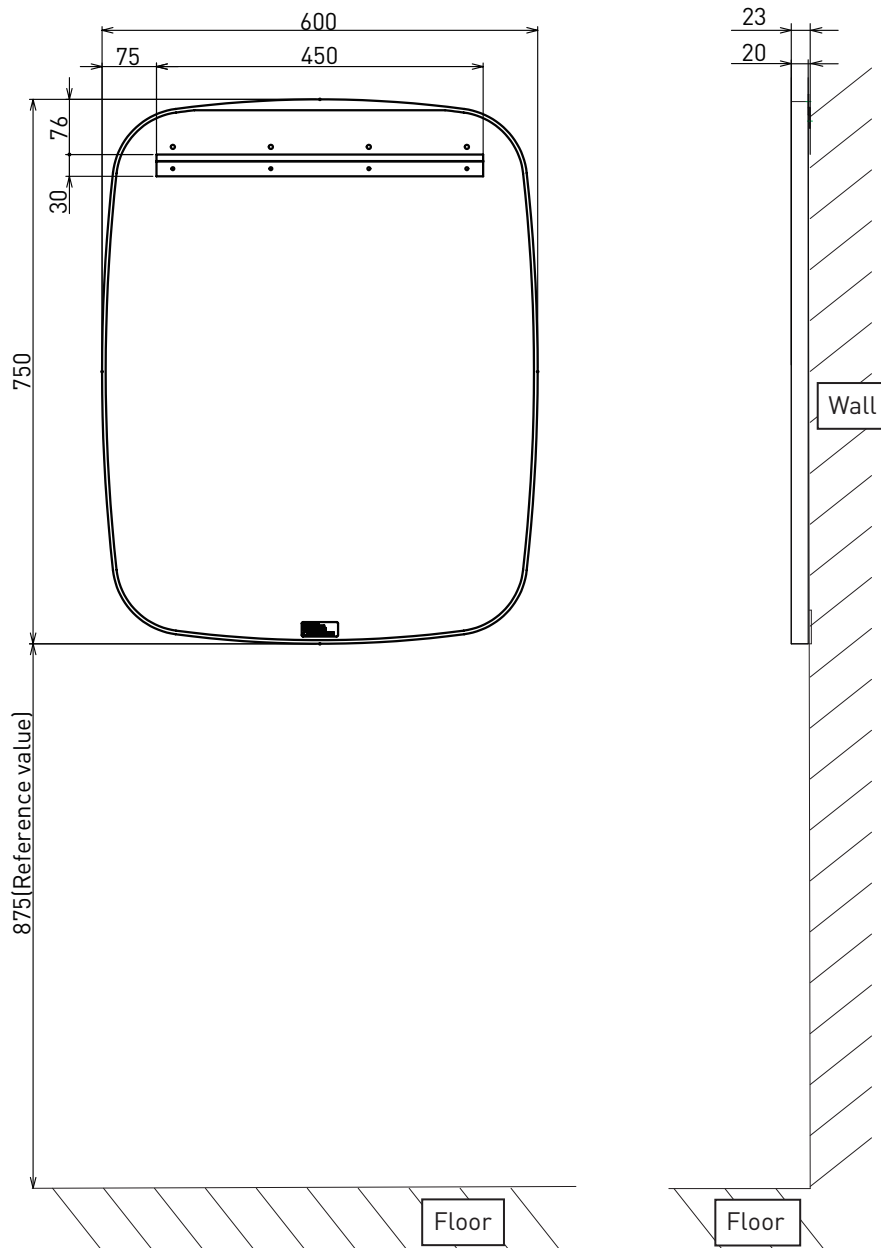

Unit : (mm)

Notes