

SPA MIST II

QUICK OPERATION GUIDE

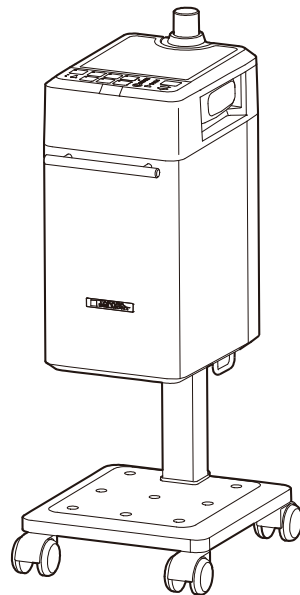

For details and safety information
see the operating instructions.

<https://manual.tb-global.net/>



1 Control Panel

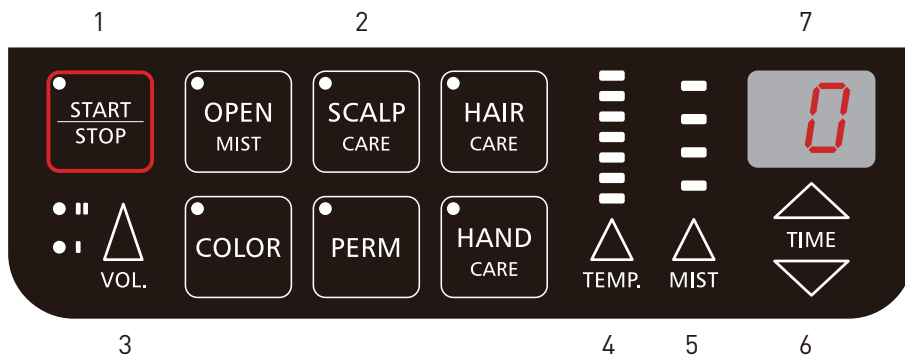

1 Start / Stop key



2 Mode selection key



Shampoo / massage with chemical agent



Heating-type permanent wave agent / curling agent



Acid hair dye
*Cooling time:5 min



Treatment
*Cooling time:2 min



Scalp cleansing agent scalp treatment



Cosmetic for hand care

3 Volume Key



Mute



Level 1



Level 2

4 Temperature Level Key

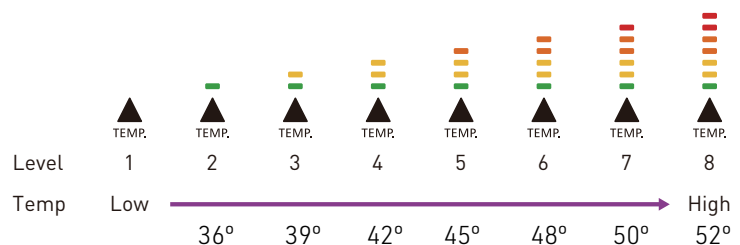

5 Mist Level Key



6 Time Set Key



7 Display panel

State indication



Time indication



Cooling and the remaining time



Shortage of water in the water-supply bottle. Re-filling distilled water



Too much water in the machine



Preheating

Error indication



Temperature detection unit error
Heater error



Temperature detection unit error



Water level detection unit error
float switch error

2 Preparation

1 Attach the cap joint N to the mist cap (option).

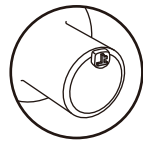
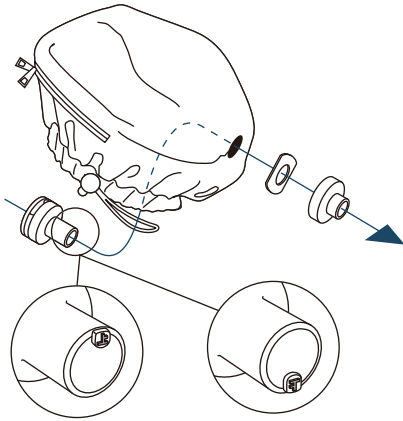

-YUME and open mist ball nozzle
-Backwash unit and YUME
-Styling chair

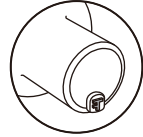

-CALME and men' s chair

2 Pour distilled water into the water-supply bottle.

1.Remove the water-supply bottle cap and pour distilled water.

 **CAUTION**

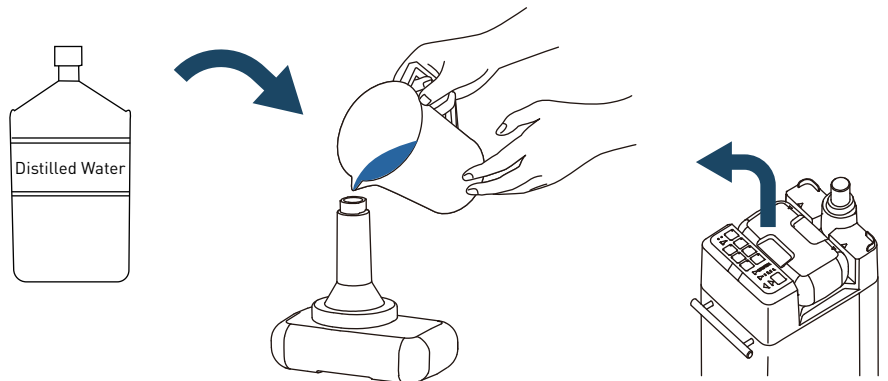

2.Close the water-supply bottle cap.

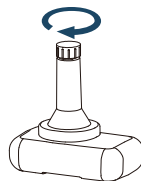

3.Empty the drain tank and ensure that the drain cock has been closed.

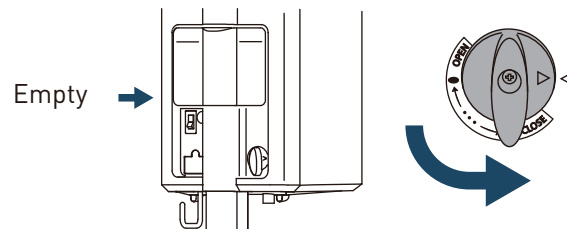

4.Insert the water-supply bottle into the top of the unit.

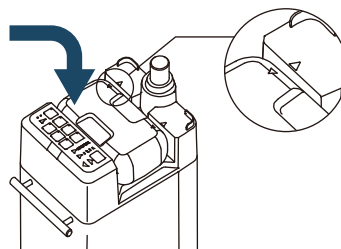

3 Operation procedures

- 1 Insert the flexible hose into the exhaust nozzle.

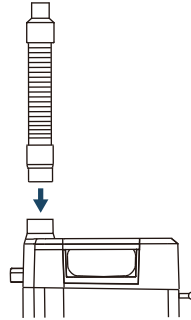
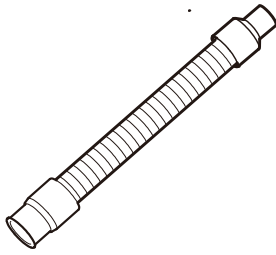

- 2 Set the main unit behind the customer.

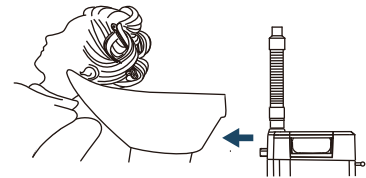
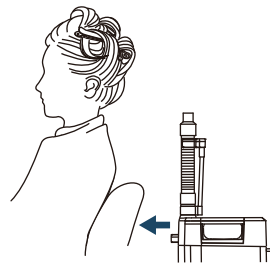

- 3 Plug in and switch on the power.

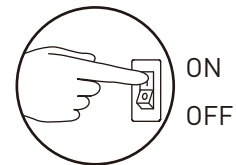
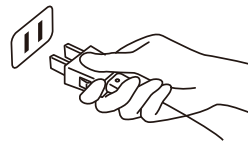

- 4 Press the key for the desired mode.



Shampoo/massage with chemical agent
*Do NOT use mist cap.



Heating-type permanent wave agent/curling agent
*An optional mist cap can be used.



Hair dye
*Cooling time: 5 min
*An optional mist cap can be used.



Treatment
*Cooling time: 2 min
*An optional mist cap can be used.



Scalp cleansing agent scalp treatment
*An optional mist cap can be used.



Cosmetic for hand care
*An optional cover can be used.

- 5 Press the start / stop key to implement pre-heating.



3 Operation procedures

Put the mist cap on and Insert the flexible hose into the cap joint N.

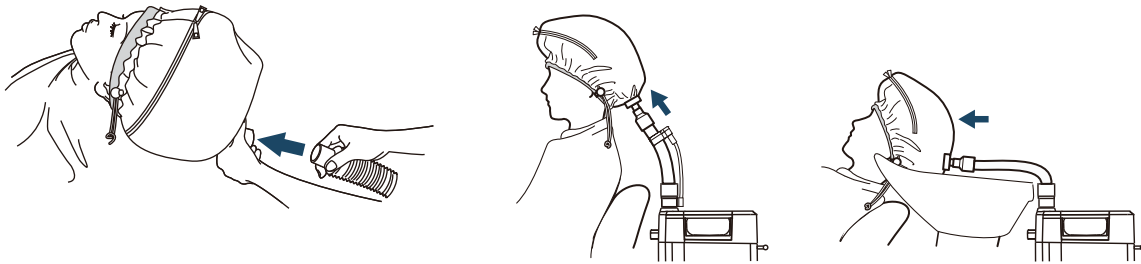

6 Press the start / stop key to start the operation.

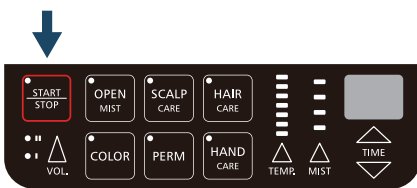

7 During operation.

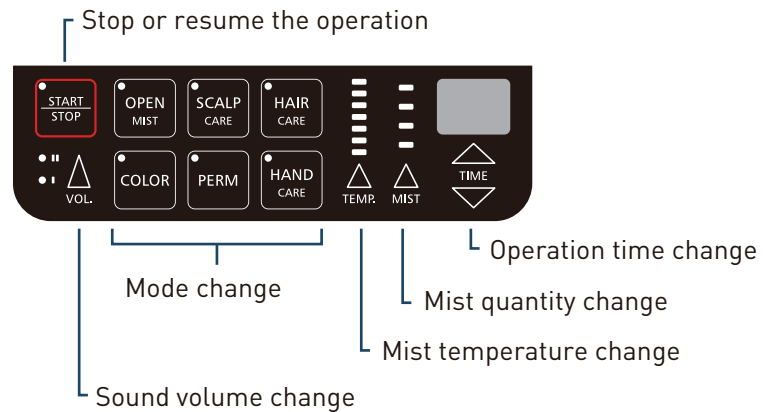

8 Cooling.



9 Time-up.

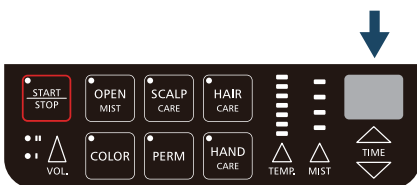

3 Operation procedures

- 10 Switch off the power after finishing the work.

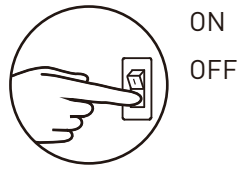

- 11 Clear out the water accumulated in the drain tank.

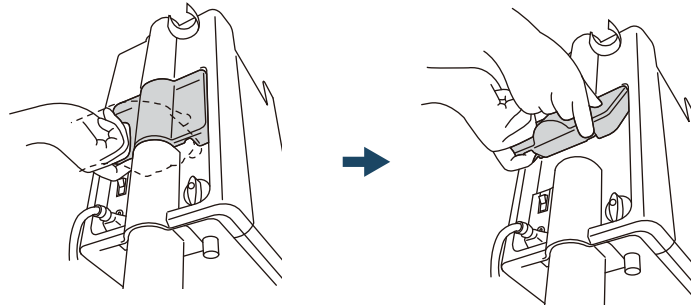

- 12 Drain the water tank after use.

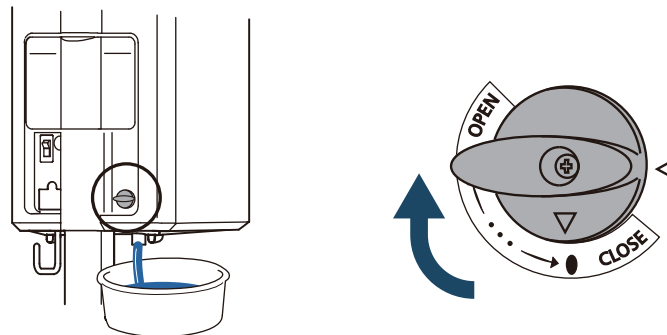

- 13 Accommodating the flexible hose.

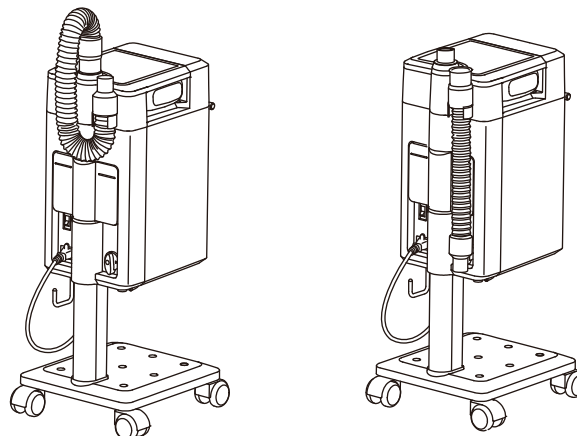

4 Putting on / removing the mist cap

1 When using a backwash setting.

Putting on the mist cap

1

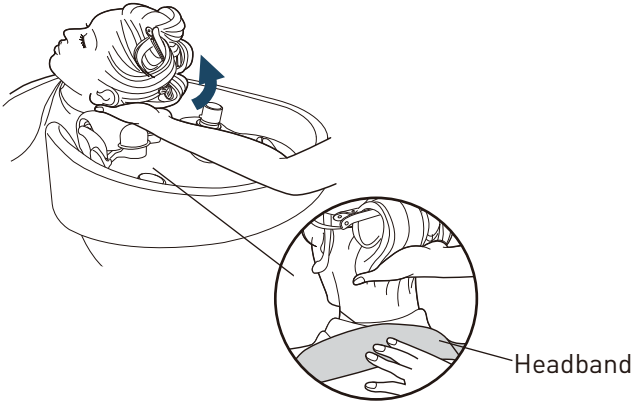

2

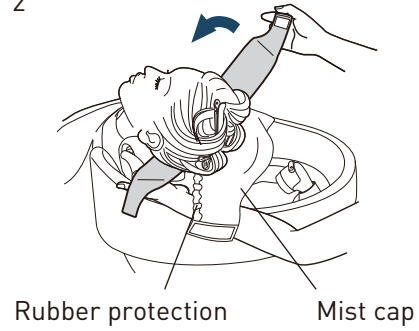

3

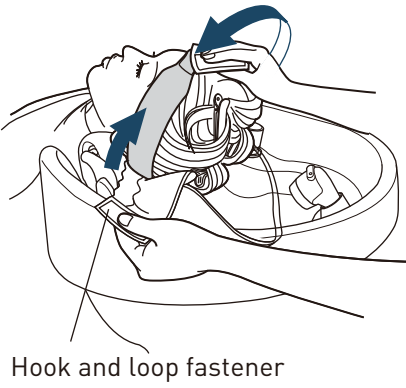

4

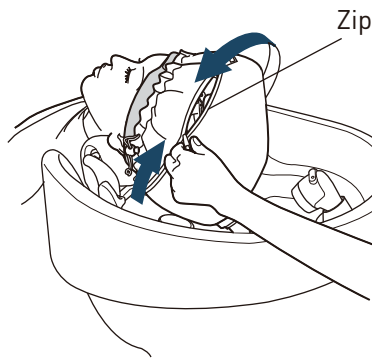

5

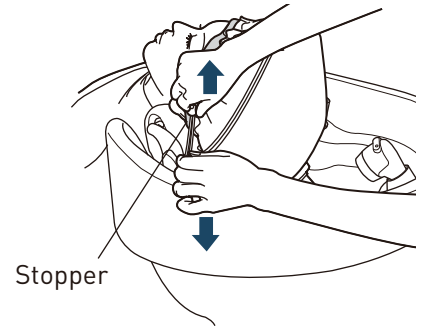

6

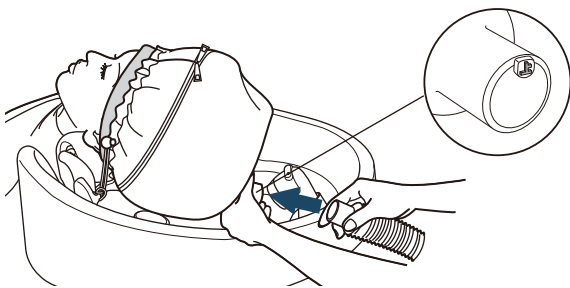

7

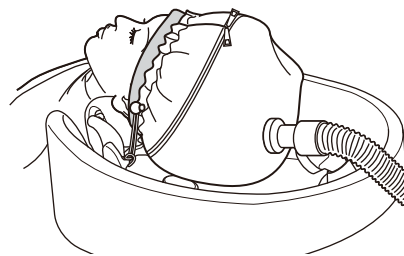

Removing the mist cap

1

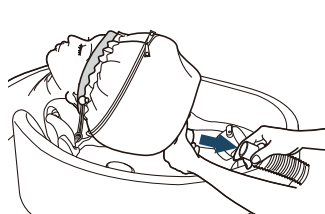

2

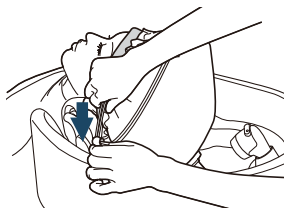

3

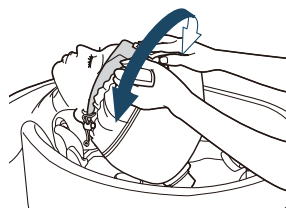

4



Video

4 Putting on / removing the mist cap

2 When using in at the Styling station.

Putting on the mist cap

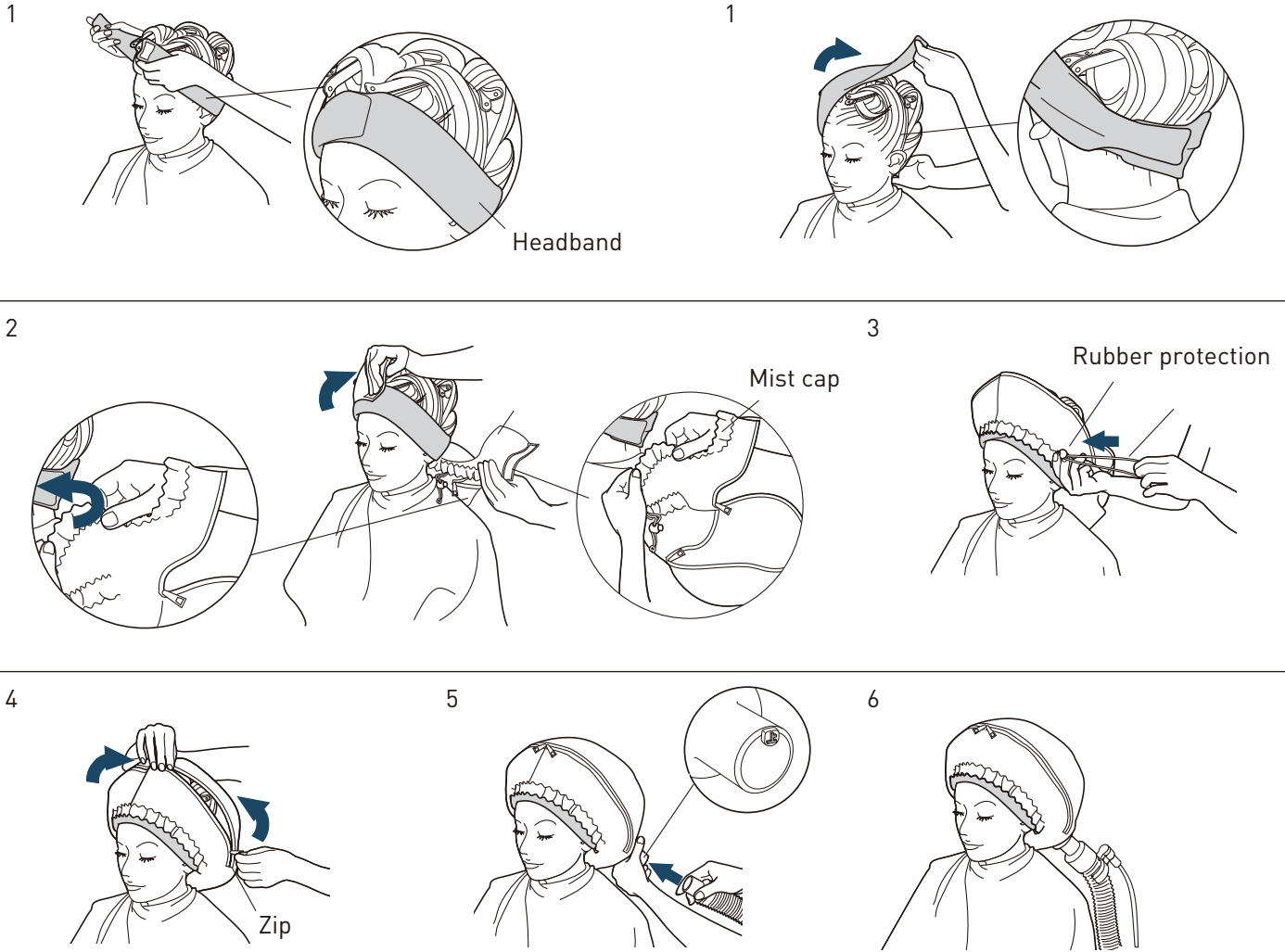

Removing the mist cap

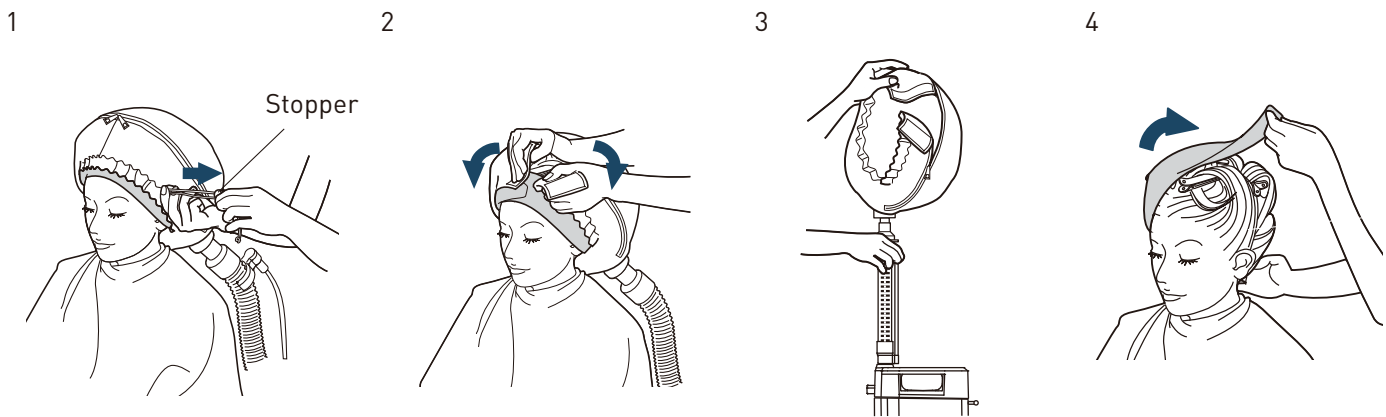

Video



TAKARA COMPANY EUROPE GmbH

Berner Strasse 18, 60437
Frankfurt am Main, Germany
TEL : +49-69-506878-0
FAX : +49-69-506878-20



TAKARA BELMONT CORPORATION



2-1-1, Higashishinsaibashi, Chuo-ku, Osaka, 542-0083, Japan
TEL : 81-6-6213-5945
FAX : 81-6-6212-3680