

YUME NAGOMI

QUICK OPERATION GUIDE

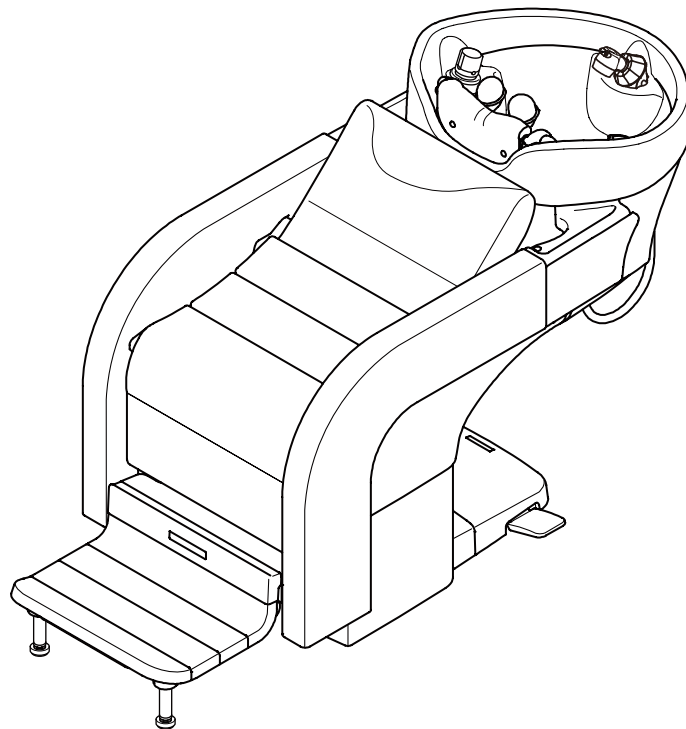

For details and safety information
see the operating instructions.

<https://manual.tb-global.net/>



1 Footrest/Reclining Pedal

Footrest

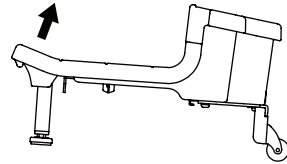
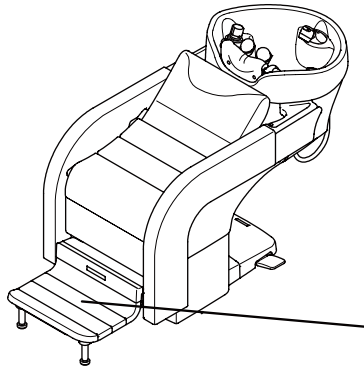

Lift up slightly when sliding the footrest

Reclining Pedal

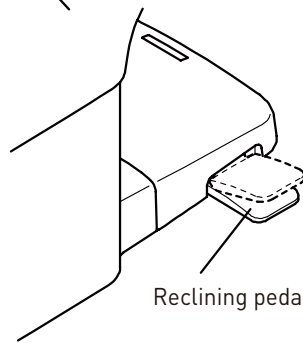
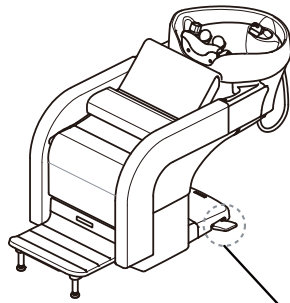

Reclining pedal

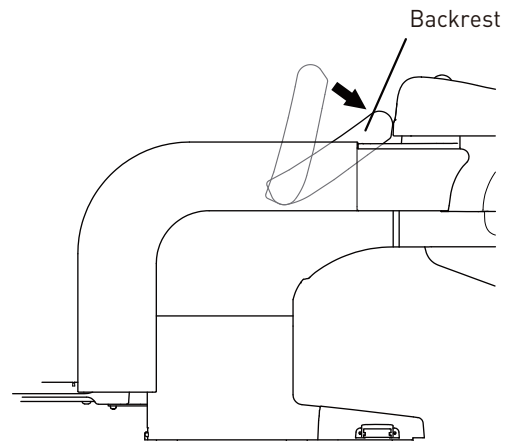

Backrest

Shampoo Basin

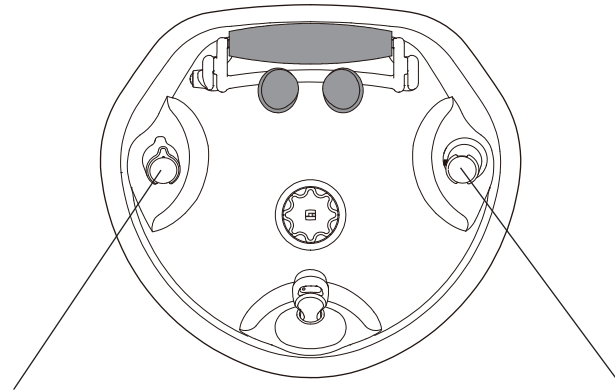

Tap

Thermostatic Control

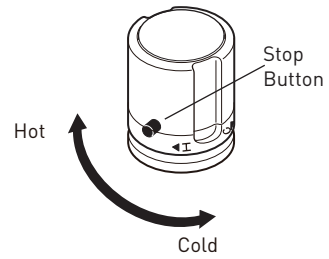
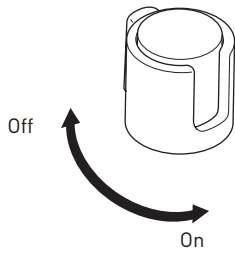

To adjust the temperature over 40 degrees, turn the knob while pressing the Stop Button

Drain Cap (Old)

Drain Cap (New)

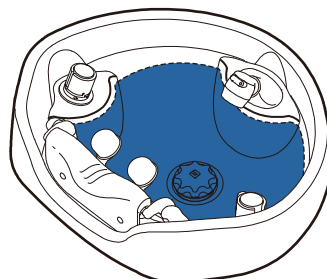
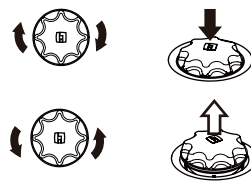

Dual Function Shower Head

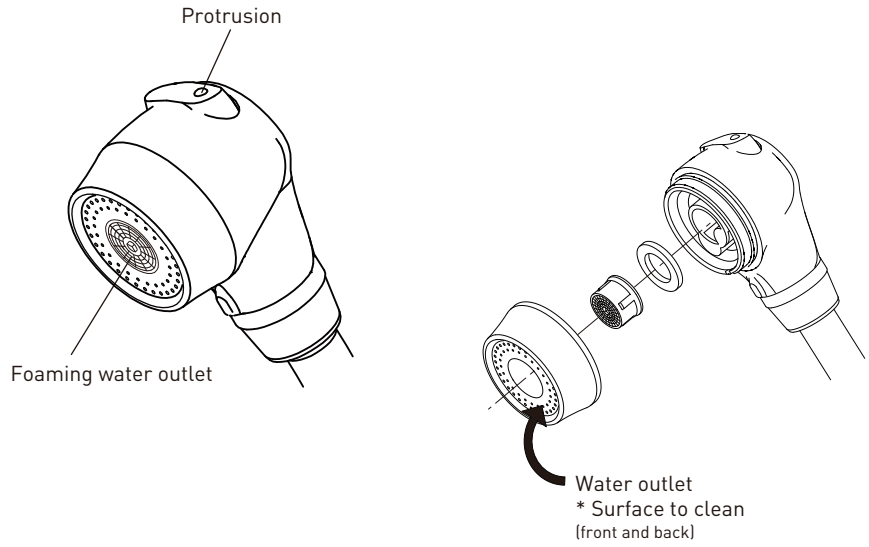

Shower Mode

<Shower Mode>



<Low Splash Foaming Mode>

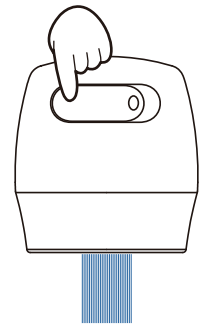

Shower Head Holder

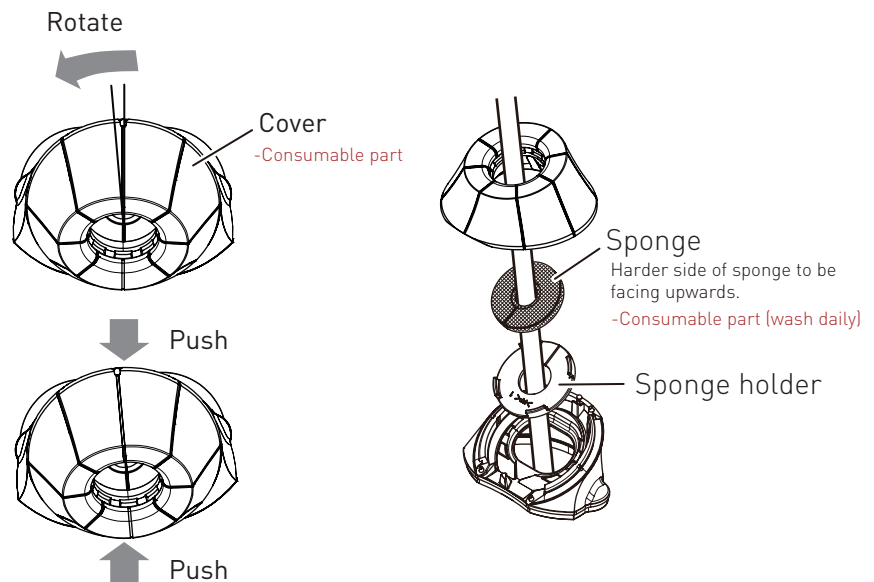

Neckrest Device (when rinsing perm lotion)

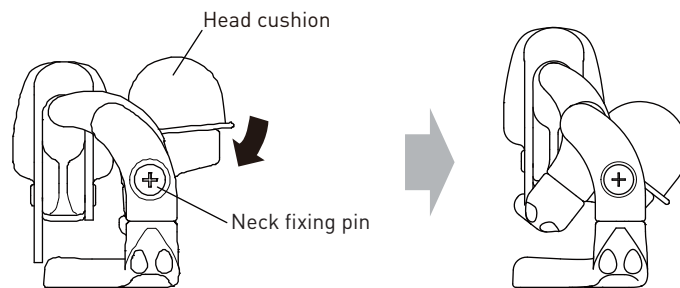

1 Rotate the head cushion as shown above

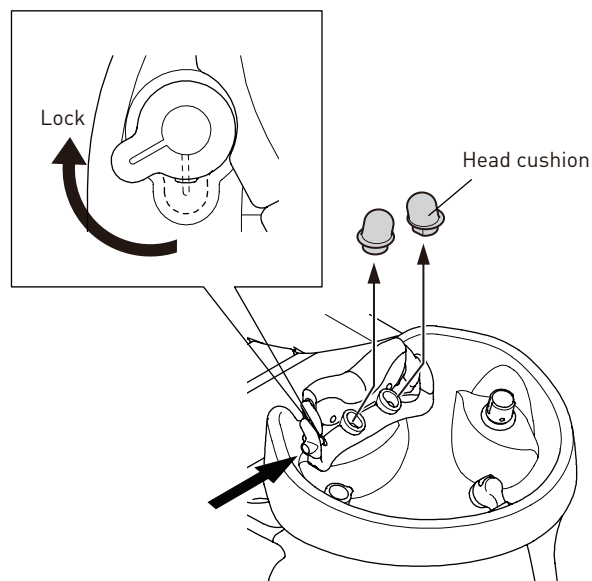

2 Lock and remove the head cushion when rinsing

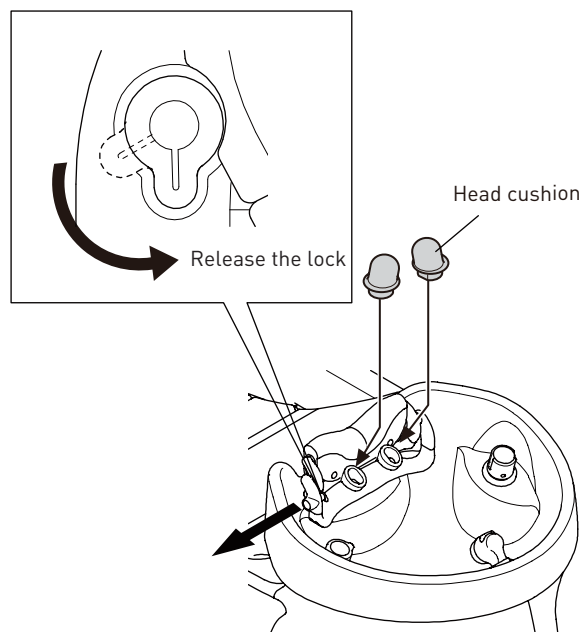

3 Release the lock and attach the head cushion back after rinsing

1 Attach the Neck Cushion and Head Pillow.

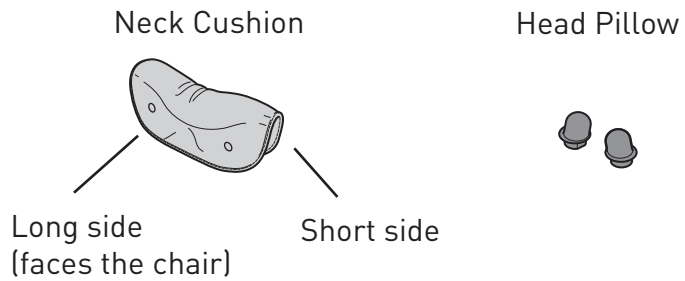

2 Attach both sides of the Neck Cushion with snap button.

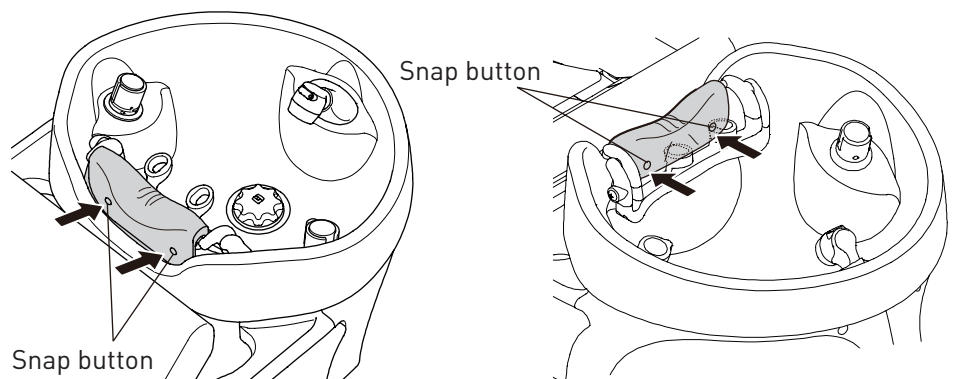

3 Attach the head pillow as shown below.

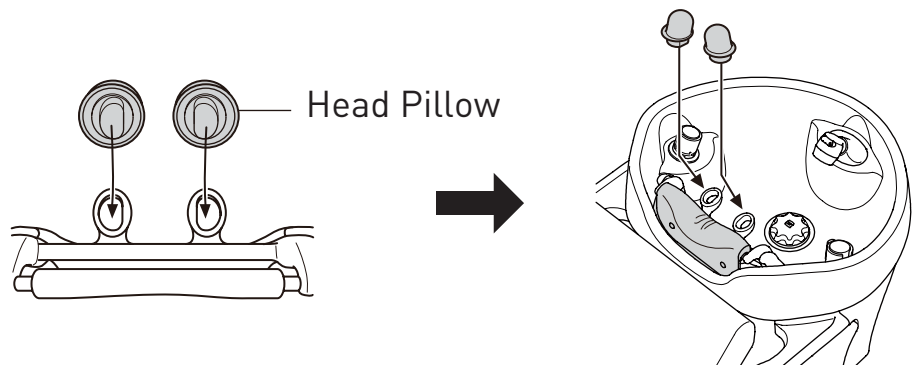

- 1 Use the reclining pedal to bring the chair to its initial position

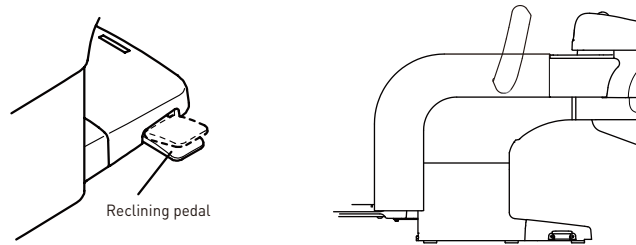

- 2 Slide out the footrest if necessary

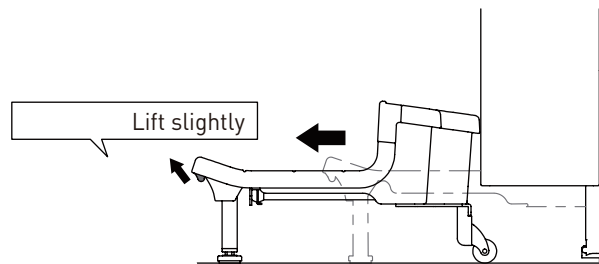

- 3 Instruct the customer to sit

- 4 When reclining the chair, follow the instructions below

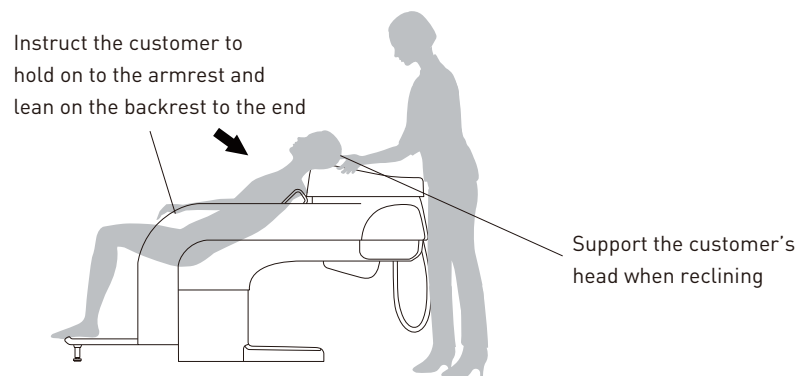

5 Adjust the angle

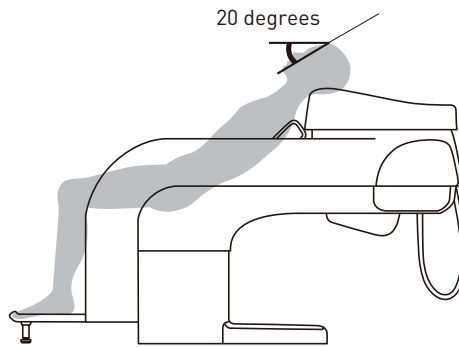

 **CAUTION**

Do not operate the reclining pedal sitting down. Always make sure there are no obstacles in the way of the backrest.

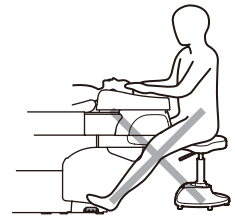

<Shampooing Style>

(Seated)

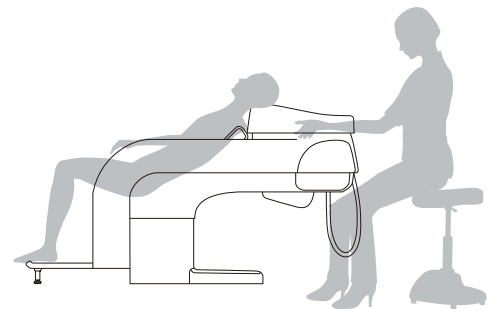

(Standing)

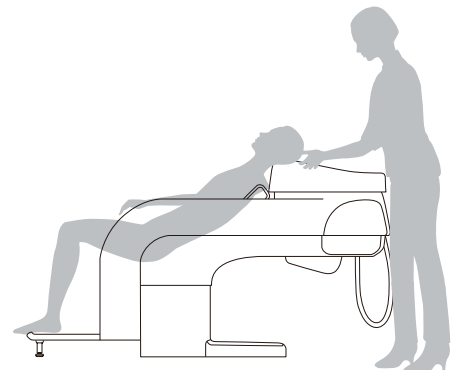

- 6 After the shampooing is done, return the chair to its initial position (support the customer's head)

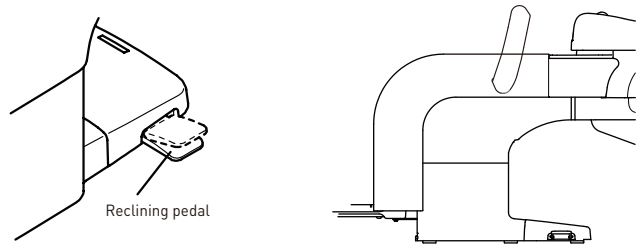

- 7 Wipe off the remaining water after use

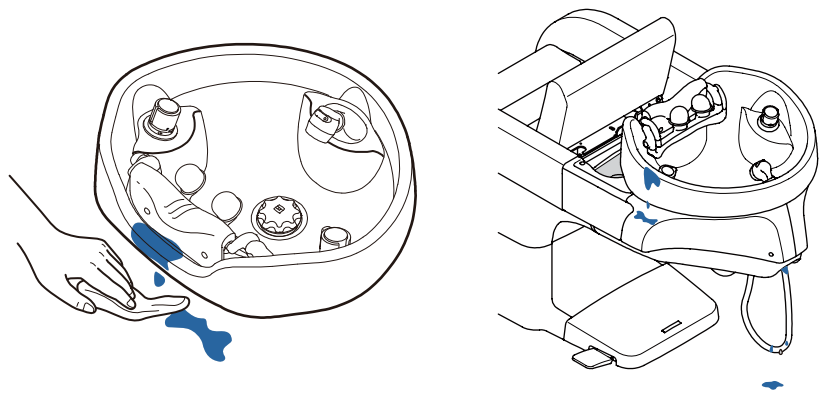

- 8 Clean the consumable parts

Neck Cushion

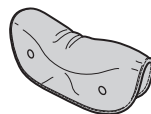

Head Pillow



Drain Cap

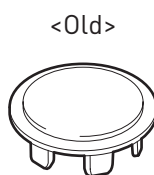

<New>

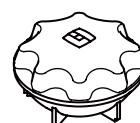

Hair Catcher

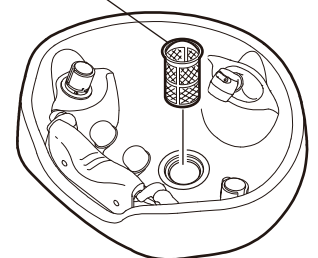



TAKARA BELMONT CORPORATION

2-1-1, Higashishinsaibashi, Chuo-ku, Osaka, 542-0083, Japan

TEL : 81-6-6213-5945

FAX : 81-6-6212-3680

