

YUME

QUICK OPERATION GUIDE

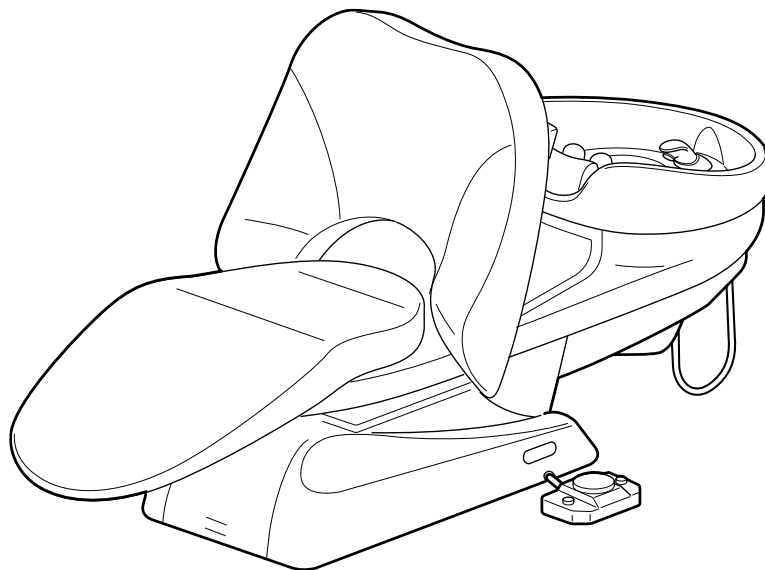

For details and safety information
see the operating instructions.

<https://manual.tb-global.net/>



1 Foot Control

EX-YML : left side foot control

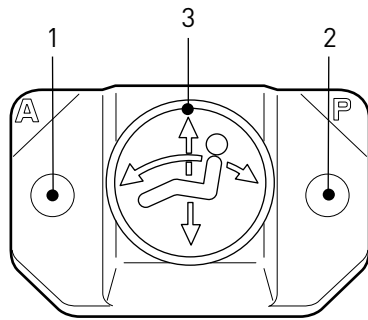

EX-YMR : right side foot control

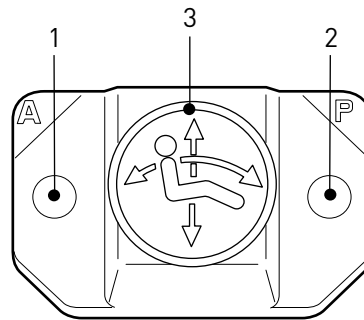

1 Auto Return Switch

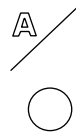

Seat fully lowered / Backrest upright position

2 Preset Switch



Chair will move to the preset position automatically

How to set the preset position

- 1) Set the chair to the desired position
- 2) Turn off the main switch
- 3) While depressing the Preset Switch, turn on the main switch
- 4) Keep depressing the Preset Switch until the buzzer sounds, then release

3 Manual Mode Control

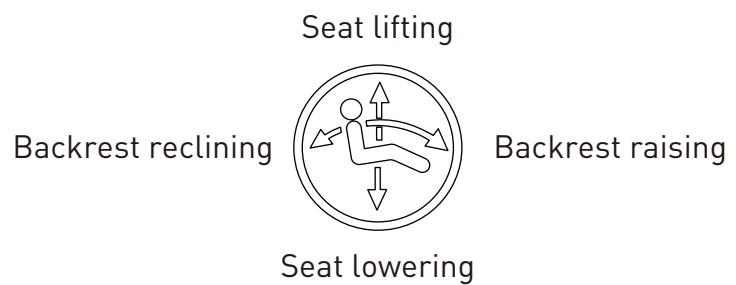

Shampoo Basin

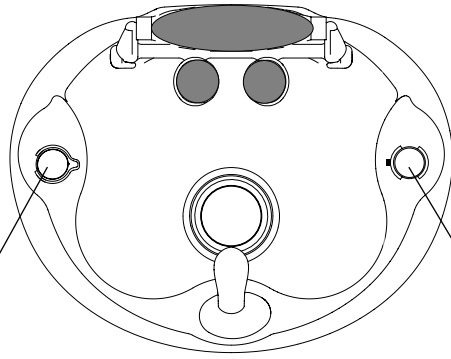

Tap

Thermostatic Control

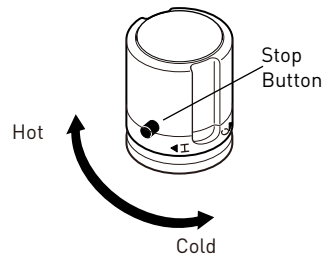
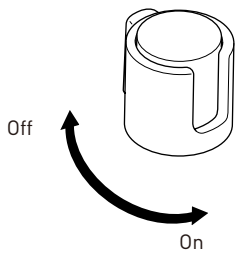

To adjust the temperature over 40 degrees, turn the knob while pressing the Stop Button

Drain Cap (Old)

Drain Cap (New)

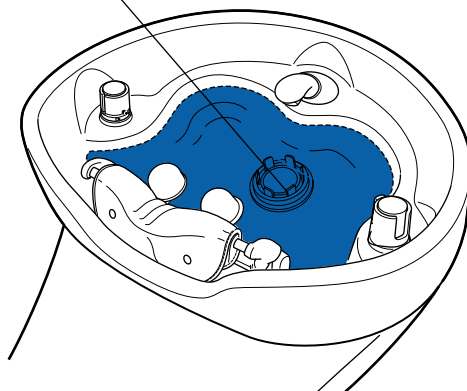
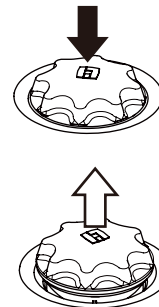
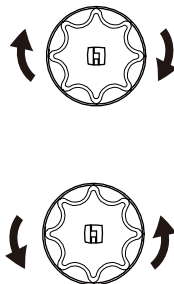

<YUME shower head>

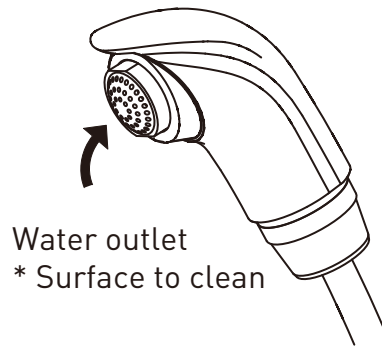

Shower head holder

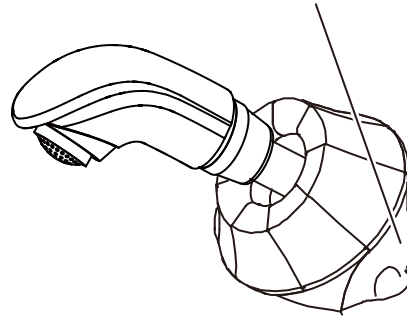

Shower Head Holder

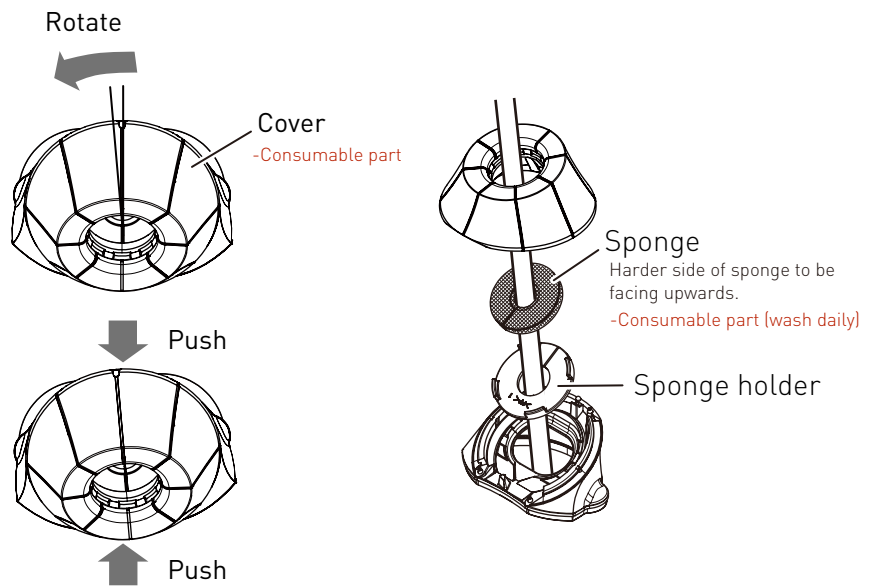

- 1 Attach the Neck Cushion and Head Pillow.

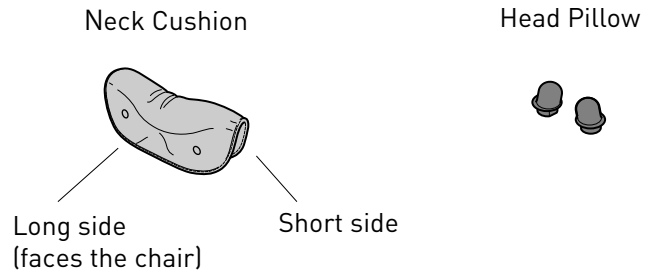

- 2 Attach both sides of the Neck Cushion with snap button.

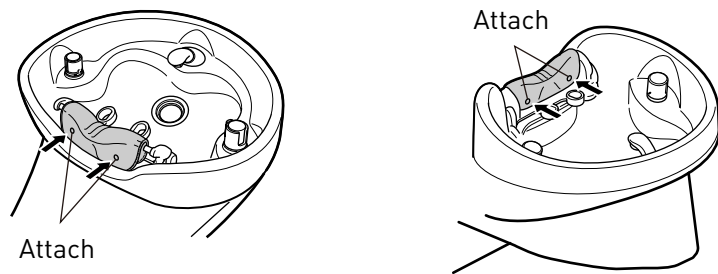

- 3 Attach the head pillow as shown below.

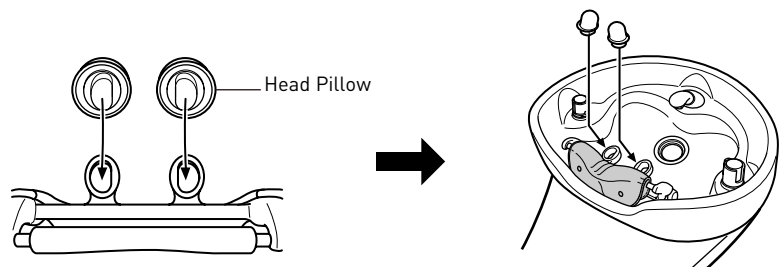

4 Operation procedures

- 1 Turn on the power.

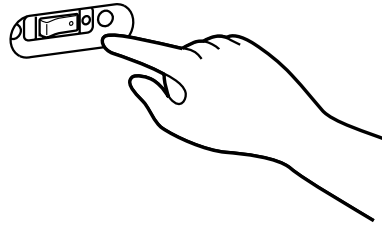

- 2 Press the auto return switch to bring the chair to its initial position.

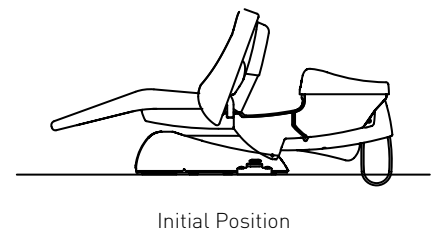
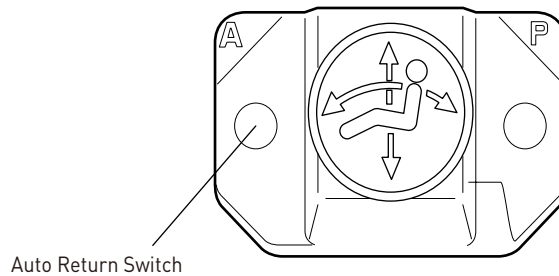

- 3 Instruct the customer to sit from the side, then face front.

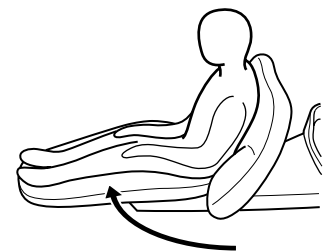
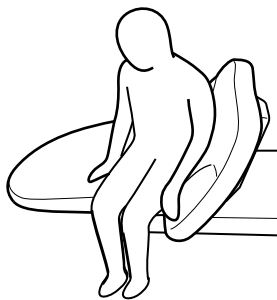

- 4 Press the preset switch (or manual mode control) to bring the chair to its approximate position.

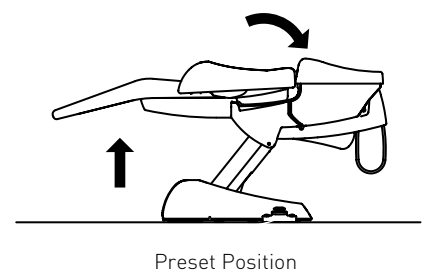
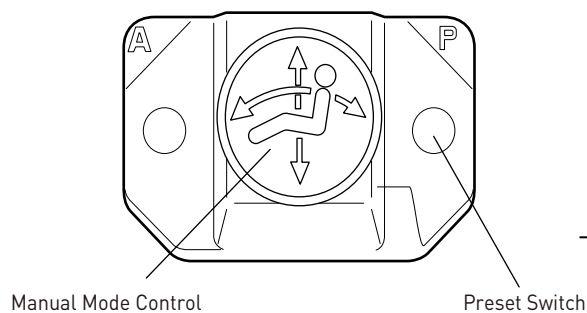

- 5 Adjust the chair height according to the shampoo technique.

<Sitting position>

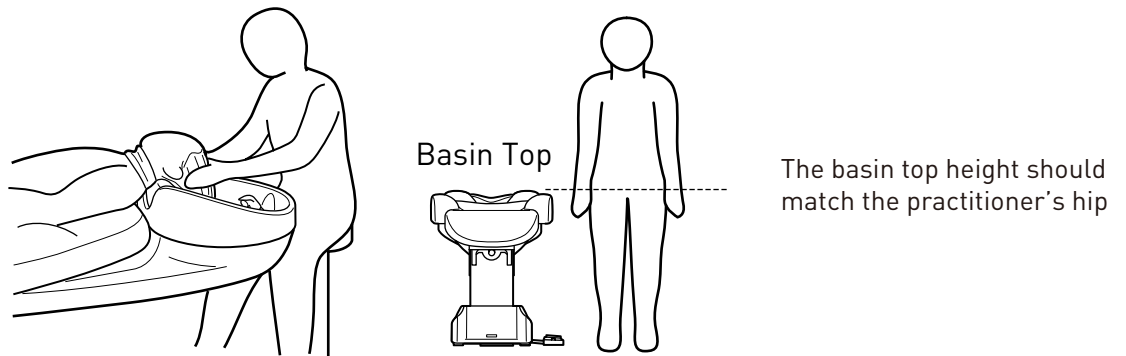

CAUTION

Do not operate the chair while the practitioner is sitting or when the stool is in the way. It may cause physical injury or property damage.

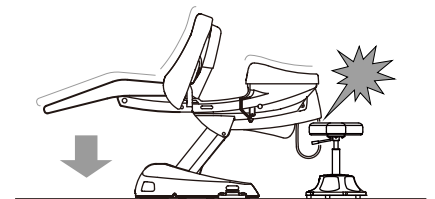

<Standing position>

Rear Shampoo



Side Shampoo



4 Operation procedures

- 6 After the shampooing, return the chair to its initial position.

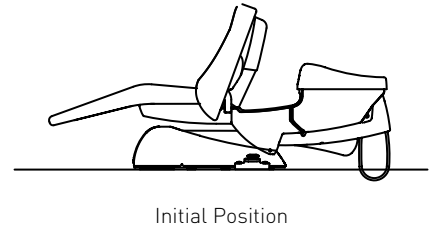
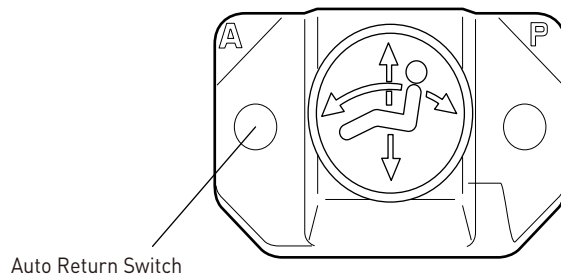

- 7 Wipe off the remaining water after use.

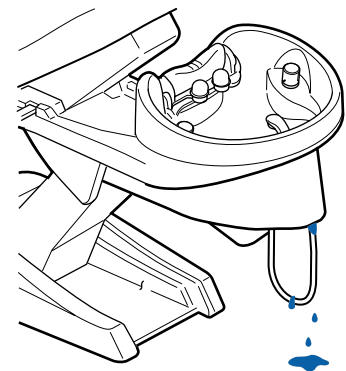
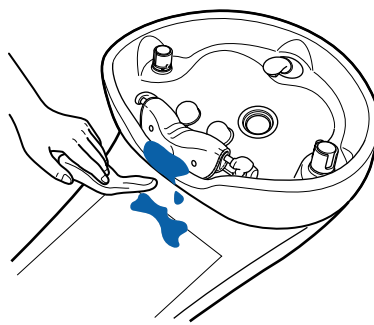

- 8 Clean the consumable parts.

Neck Cushion

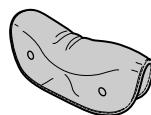

Head Pillow



Drain Cap

<Old>

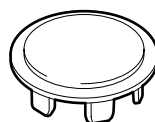

<New>

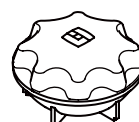

Hair Catcher

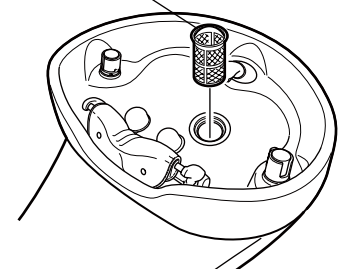



TAKARA BELMONT CORPORATION

2-1-1, Higashishinsaibashi, Chuo-ku, Osaka, 542-0083, Japan

TEL : 81-6-6213-5945

FAX : 81-6-6212-3680

